



 **TAURUS™**

TH SERIES

INSTRUCTION MANUAL

GENERAL SAFETY, OPERATING INSTRUCTIONS AND LIMITED WARRANTY

READ CAREFULLY BEFORE USING YOUR FIREARM

Important: Keep this manual with your firearm.

The information contained in this manual is useful, both for beginners and experienced shooters. In addition to important information about the function, cleaning and care of the firearm, this manual contains instructions that may be very helpful in shooting safely.

The most important rule of safe firearm handling is always keep the muzzle pointed in a safe direction!



TH SERIES

TaurusUSA.com

 /TaurusUSA

 @taurususa

 /TaurusUSA

- Available in 9mm Luger, .40 S&W, 10mm AUTO, and .45 AUTO
- Finish Matte Black or Matte Stainless slide
- 3 dot sights
- DA/SA Trigger
- Ambi-Controls
- Loaded Chamber Indicator
- Taurus Memory Pad™
- Manual Safety

CONTENTS

| | |
|------------------------------|----|
| Firearms Safety | 6 |
| Get To Know Your Pistol..... | 14 |
| Ammunition | 18 |
| Operating Instructions..... | 22 |
| Disassembly | 26 |
| Assembly | 30 |
| Care and Maintenance..... | 31 |
| Exploded View..... | 32 |
| Taurus® Service | 34 |
| Limited Warranty | 36 |

WARNING



The safety warnings in this booklet are important. By understanding the dangers inherent in the use of any firearm, and by taking the precautions described herein, you can safely enjoy your Taurus® firearm. Failure to follow any of these warnings may result in serious injury to you or others, as well as severe damage to the firearm or other property.

Intentionally left blank

NOTES

Four horizontal grey bars intended for handwritten notes.

SIGNAL WORDS AS DEFINED BY ANSI Z535.6 AND Z535.4 STANDARDS.

| | |
|--|--|
|  DANGER | DANGER indicates a hazardous situation which, if not avoided, will result in death or serious injury. |
|  WARNING | WARNING indicates a hazardous situation which, if not avoided, could result in death or serious injury. |
|  CAUTION | CAUTION indicates a hazardous situation which, if not avoided, could result in minor or moderate injury. |
| NOTICE | NOTICE is used to address practices not related to physical injury. |

FIREARMS SAFETY

WARNING

When a firearm discharges, the bullet or shot can strike a person, resulting in death or serious bodily injury.

The three basic keys to safe handling of firearms:

- 1. KEEP YOUR FINGER OFF THE TRIGGER UNTIL YOU ARE READY TO FIRE.** If you maintain good trigger discipline, it is extremely unlikely the firearm will fire.
- 2. KEEP THE MUZZLE POINTED IN A SAFE DIRECTION.** Even if the firearm discharges, if the muzzle is pointed in a safe direction, no one will be injured.
- 3. NEVER TRUST ANY SAFETY MECHANISM.** If you adopt the attitude that you will not trust any safety mechanism, you will be vigilant about keeping your finger off the trigger and keeping the muzzle pointed in a safe direction.

WARNING - KNOW YOUR TARGET

Never fire at targets at close range. Ricochets can and do cause death or serious bodily injury. What constitutes "close range" depends on many factors including target material, bullet caliber and angle of impact.

KNOW WHAT IS BEHIND YOUR TARGET. Unless you are shooting into a bullet trap designed to capture the type of ammunition you are firing, projectiles may pass through the target and strike anyone or anything beyond. Bullets can travel miles.

ALWAYS WEAR HEARING PROTECTION. Firearms are loud. The sound they generate is greater indoors. Repeated exposure to loud noises can cause deafness. Hearing protection is rated by decibel reduction. Look for "dB" reduction of 30 or more when purchasing ear protection. Modern ear protection can allow normal hearing until the sound from the discharge reaches the ear. Layering hearing protection, for example, wearing 30db rated foam plugs with 20db rated ear muffs, significant protection can be achieved.

ALWAYS WEAR EYE PROTECTION. In normal operation, firearms emit hot high-velocity gases, particles and metal. These materials flying into your eye can cause blindness. Protect your vision with proper eye protection. Any eye protection may be better than none, but look for ANSI Z87.1-2003 certified eyewear for the best protection.

NEVER HANDLE FIREARMS WHILE UNDER THE INFLUENCE OF DRUGS OR ALCOHOL. Firearms are dangerous. Handling firearms while impaired by drugs or alcohol is foolhardy and may result in serious injury or death. This warning includes prescription drugs that contain a warning about using machinery or driving while taking the medication.

MODIFIED FIREARMS ARE DANGEROUS, AND USE CAN RESULT IN SERIOUS INJURY OR DEATH. "Trigger jobs," polishing original components or installing aftermarket parts can cause a firearm to function in ways different than intended. Some such work may also be illegal.

DAMAGED FIREARMS ARE DANGEROUS, AND USE CAN RESULT IN SERIOUS INJURY OR DEATH. Repairs should always be made by a qualified gunsmith or by a factory-authorized repair site. Work done by those unfamiliar with the design can cause a firearm to function in ways different than intended.

NEVER ATTEMPT TO DISASSEMBLE OR CLEAN A LOADED FIREARM. DOING SO CAN RESULT IN SERIOUS BODILY INJURY OR DEATH. How often have we heard "But it went off while I was cleaning it!" or, "I did not know it was loaded!" or, "It was jammed, and I tried to take it apart!"?

IF A FIREARM GOES OFF, THERE WAS A ROUND OF AMMUNITION IN THE CHAMBER. Period. "Clear" (or empty) the firearm of all ammunition before disassembling or cleaning.

As owner of your new Taurus® firearm, you are responsible for (1) keeping your finger off the trigger, (2) pointing the muzzle in a safe direction, (3) removing the magazine, (4) pulling the slide to the rear and locking it back and (5) looking and feeling in the magazine well and chamber to confirm the pistol is empty. An empty firearm cannot fire.

FIREARMS SAFETY SYSTEMS

Firearms safety is supported by a system. With your pistol, the system is made up of the following:

1. You! Your involvement in safety cannot be overemphasized. No safety component can keep your finger off the trigger and the muzzle pointed in a safe direction. Also, you are the key to never trusting any of the mechanical parts of the safety system.

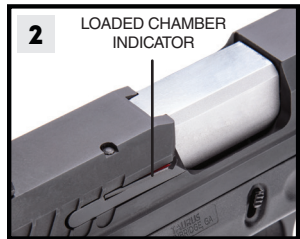

2. Loaded chamber indicator. When a cartridge is loaded in the chamber, the loaded chamber indicator protrudes from the right side of the slide just behind the ejection port, and its surface can be seen or felt without the need for pulling the slide back to check the chamber.



WARNING

The loaded chamber indicator should never be used as a substitute for visually checking or feeling for an empty chamber with your finger when “clearing” or emptying a pistol.



3. Manual Safety. Always use the manual safety. You paid for it, use it. When you need it to work, it needs to be all the way in the Safe position, not half way or at some other point in its travel. Don't play with the manual safety and you will avoid accidents.



4. Hammer Drop (Hammer Decocker). This mechanism allows you to decock the hammer safely. The pistol remains ready to fire, in Double Action mode. Do not pull the trigger to decock the pistol.

5. Taurus Memory Pad™. It is important to keep your finger off the trigger until you are ready to press the trigger and fire the pistol. If you keep your finger off the trigger you will not press it by accident and fire the pistol before you are ready to do so, thereby avoiding accidents. The Memory Pad gives you a consistent place to put your trigger finger off the trigger, but in a ready position.



6. Firing Pin Block. The firing pin block interferes with the forward travel of the firing pin until the trigger is pulled. Like a trigger safety, pressing the trigger moves this safety component from its “safe” (blocking) position to its “fire” (free) position.

7. Trigger Guard. This is a physical obstruction that helps prevent unintended pressing of the trigger or trigger safety. Do not modify the trigger guard.

8. This Manual. Taurus intends for you to use this manual to learn about your pistol and to help you use your pistol safely. If you use the manual, you will go a long way toward being a knowledgeable and safe firearms owner.

9. Online Resources. TaurusUSA.com hosts a library of videos concerning safety and related issues. This library is being supplemented and revised. Please visit the site and take advantage of what is available there as part of your education regarding using your Taurus pistol in a safe fashion.

PISTOL AND REVOLVER SIZE AND SAFETY

The selection of a revolver versus a pistol as well as the size, caliber and magazine capacity of a handgun are personal choices. There are many choices to be made, and there are advantages and disadvantages for each. When selecting a pistol, size has safety implications because of the way pistols are loaded.

Generally speaking, smaller handguns may require more attention to be handled safely than medium or full-size handguns. This is because their small size makes it easier to point the muzzle at your hand or to “sweep” (swing the muzzle across your body) yourself or others in ordinary handling.

When chambering a round, we recommend pulling the slide to the rear by gripping the rear of the slide, with the muzzle pointed straight and away from your body and in a safe direction.

SAFE CARRY CONDITION

“Safe Carry Condition” is the most ready-to-fire condition that the user feels is reasonable under the circumstances. Generally, we believe that Taurus® pistols should be carried with a full magazine and an empty chamber. Under most circumstances, this provides the best balance of readiness and safety. On the plus side, if the chamber is empty, unintended discharges are minimized. However, the slide must be manipulated to load a round in the chamber. In emergency circumstances, this can be difficult to do safely and correctly.

If the user believes that he or she is faced with an increased threat, chambering a round is appropriate. For safety reasons, this should be done beforehand with the muzzle pointed in a safe direction, and your finger off the trigger. How do you know you may be going into a more dangerous situation? That depends. If, for example, you carry cash to deposit after a business closing, this may well qualify. If a domestic partner is actively threatening you, this may qualify as well.

“Safe Carry Condition” is a judgment call and must be made by the user. Some users routinely face greater threats than others. Users must be aware of their situation and circumstances. Errors in judgment can have dire and tragic outcomes if firearms are present.

CARRYING FIREARMS

Carrying a firearm can be dangerous. Carrying a firearm makes it more difficult to control the muzzle and makes it more likely that the firearm can be dropped or bumped causing the firearm to fire.

In almost all circumstances, it is safest to carry a handgun in a holster designed for that specific handgun. Carrying a handgun in a pocket without a specific designed In-Pocket Holster or a trigger shield or in a waist band without a belt clip is always a last choice. Carrying any handgun in a holster that fits the firearm and style of carry should prevent it from accidentally falling and you from losing control of the muzzle.

Except in rare high-threat circumstances, carry your pistol with a full magazine and an empty chamber. If the chamber is empty, the pistol cannot fire.



WARNING - CARRYING

Do not carry your firearm in any way that might let it fall or be bumped. If a firearm falls or is bumped, it may fire.



WARNING - CARRYING

Always review and follow the holster or luggage manufacturer's instructions or the firearm may fall or be bumped and fire.

FIREARMS STORAGE AND GUN LOCKS

How you secure your firearms is a personal choice based on the unique circumstances in your home, business or vehicle and the laws of the state where your firearm is located. Any choice you make about securing your firearms will present advantages and disadvantages. It is up to you to weigh those advantages and disadvantages and choose which security method is best for you and those around you.



WARNING - LOCKING

Never lock a firearm with a round of ammunition in the chamber. Unlocking a loaded firearm makes it more difficult to maintain trigger discipline and to keep the muzzle pointed in a safe direction.



WARNING

Securing your firearm may inhibit access in a defensive situation and may result in injury or death.



WARNING

Failure to secure a firearm may result in injury or death. Properly securing a firearm means storing your firearm unloaded, decocked and securely locked, with all ammunition in a separate location.

GET TO KNOW YOUR PISTOL



SPECIFICATIONS

| Model | TH 9 | TH 40 | TH 9C | TH 40C | TH 10 | TH 45 |
|--------------------------|--|-----------|---------------|-----------|--|-----------|
| Caliber | 9mm Luger* | .40 S&W | 9mm Luger* | .40 S&W | 10mm AUTO | .45 AUTO |
| Action | Double and single action | | | | | |
| Magazine capacity | 17 rounds | 15 rounds | 13 rounds | 11 rounds | 15 Rounds | 13 rounds |
| Barrel length | 4.27" | | 3.54" | | 4.28" | |
| Total length | 7.72" | | 6.85" | | 7.83" | |
| Total height | 5.98" | | 5.16" | | 5.8" | |
| Grip width | 1.30" | | 1.30" | | 1.43 | |
| Weight | 28.2 oz. | 27.5 oz. | 25.0 oz. | 24.7 oz. | 28 oz | 27.5 oz. |
| Sights | Drift Adjustable, 3 dots system | | | | Serrated steel rear sight (Adjustable) Steel front sight with white dot | |
| Material | Barrel and Slide: Steel | | Grip: Polymer | | | |
| Safety devices | Firing Pin Block Manual Safety (Ambidextrous on Full Size models) Hammer Decocker (Ambidextrous on Full Size models) Loaded Chamber Indicator | | | | | |
| Finish | Black Tenifer | | | | | |
| Remarks | Ambidextrous slide catch (Full Size models) and magazine release (All models) Accessory rail (Picatinny / MIL-STD-1913) Adjustable backstrap (Full Size models only) | | | | | |

NOTICE

*9mm Luger is a cartridge caliber also commonly known as: 9mm / 9x19 / 9x19mm / 9mm Parabellum / 9mm Para

LOCKING DEVICE INSTALLATION INSTRUCTIONS



WARNING - LOCKING DEVICES

- Always keep your firearm pointed in a safe direction, including when you are installing or removing your locking device.
- Always verify that your firearm is completely unloaded (see page 17) before installing your locking device.
- Do not install locking devices in the trigger guard; always keep your fingers and locking device outside the trigger guard during device installation and removal.
- Store firearms, ammunition and keys separately and securely, away from children and careless adults; do not store your firearm with the keys in the locking device.
- Do not attempt to work the action of your firearm with the locking device in place; this may damage your firearm.
- While locking devices are an important aid to security measures, they are not a substitute for safe firearm handling and proper storage. Remember that any mechanical device can be bypassed with enough time, knowledge, determination and equipment.

LOCKING DEVICES MUST BE USED SAFELY AND RESPONSIBLY

It is important to use the locking device on your Taurus® firearm!

Keep the muzzle pointed in a safe direction and your fingers outside the trigger guard at all times during installation of the locking device!

To Install the Factory-Supplied Locking Device:

1. Remove the magazine from your pistol.
2. Open the action completely, and verify that the firearm is completely unloaded and contains no cartridges or cartridge cases! Use the slide stop to keep the action open during installation of the locking device.
3. Insert the cable directly in your pistol as shown in Figure 1.
4. To lock: With the key turned to the farthest clockwise position, insert the loose end of the cable into the lock. Turn the key counterclockwise and remove the key.
5. Once the lock is securely closed, pull firmly on the lock to test the connection and be sure it is locked. Do not leave or store your firearm with the key in the lock! Store your locked, unloaded firearm and the key in secure, separate locations, away from ammunition, children, and unauthorized adults



WARNING

Never leave your keys in the lock when the lock is installed on the firearm.

AMMUNITION

WARNING

Using the wrong ammunition in your pistol can result in serious bodily injury and damage to your pistol. Make certain the ammunition you load in the magazine is the same caliber as is marked on the pistol.

WARNING - AMMUNITION AND INDUSTRY STANDARDS

Use only clean, dry factory-loaded ammunition. Old, damaged, wet or oily ammunition may fire at pressures higher than industry standard, causing injury to you and bystanders or damage to your pistol.

Do not use reloaded ammunition in your pistol. Its firing pressures are unknown and may well exceed industry standard, causing injury to you and bystanders or damage to your pistol.

Odd sounds are signs of trouble. If a round “does not sound right” when it goes off, stop firing right away. A bullet may be stuck in the barrel. Firing the pistol in this condition may cause pressures higher than industry standard, causing injury to you and bystanders or damage to your pistol.

If you hear any odd sounds when firing your pistol, stop firing, clear the pistol and “field strip” (or disassemble) the pistol in accordance with the procedures listed in this manual. Once the barrel is removed from the slide, look down the bore. If you do not see light, there is something stuck in the bore. Do not fire the pistol again, and take the pistol to a competent gunsmith or contact the Taurus Service Department at 800-327-3776.

WARNING - LEAD EXPOSURE

Discharging firearms in poorly ventilated areas, cleaning firearms or handling ammunition may result in exposure to lead and other substances known to the state of California to cause birth defects, reproductive harm and other serious physical injury. Have adequate ventilation at all times. Wash hands thoroughly after exposure with soap and cold water.

SHOOTING OR CLEANING GUNS MAY EXPOSE YOU TO LEAD

WARNING

“+P” ammunition can be dangerous. There is a detailed discussion about “+P” and “+P+” ammunition on page 20 of this manual. Until you have read that information, do not fire any ammunition marked “+P” in your pistol.

WARNING

Never fire ammunition marked “+P+” in your pistol. It does not comply with industry standards as to chamber pressures.

WARNING

It is DANGEROUS to fire “+P+” ammunition in any Taurus® firearm, and doing so may result in serious bodily injury or death. The Sporting Arms and Ammunition Manufacturers Institute (SAAMI) does not recognize any “+P+” ammunition at all. These loads operate at unknown pressures.

There are only four calibers that can carry a “+P” rating from SAAMI. They are 38 Special +P, 9mm Luger +P, 38 Super Automatic and 45 Automatic +P. There are no other SAAMI approved “+P” loads. Any ammunition in any other caliber marked “+P” is not SAAMI compliant, may be dangerous and should not be used.

Only fire SAAMI rated Plus P (“+P”) ammunition in Taurus® models designated by Taurus for +P use as below. **Firing +P ammunition in other Taurus products may be dangerous and can result in serious bodily injury or death.**

Model 85 small-frame revolver in 38 Special.

Model 850 small-frame revolver in 38 Special.

Model 851 small-frame revolver in 38 Special.

Model 85 Polymer small-frame revolver in 38 Special.

Model 82 medium-frame revolver in 38 Special.

Model 817 compact frame (tracker) revolver in 38 Special.

All firearms chambered in 38 Super Automatic.

All firearms chambered in 45 Automatic (ACP).

All firearms chambered in 9mm Luger.

NOTICE

Even if your Taurus® firearm is rated for Plus-P (“+P”) ammunition, such ammunition generates pressures significantly in excess of the pressures associated with standard ammunition. Such pressures may affect the useful life of the firearm or exceed the margin of safety built into many firearms. Unless you need +P ammunition, do not use it, particularly for practice.

FIREARMS ARE NOT ALL ALIKE

Many makes and models of firearms might LOOK nearly the same. However, they differ widely in design, operation, and in the location and function of various controls. You may access the Taurus® website at TaurusUSA.com to view and print manuals.

“JAMS”

SOMETIMES A CARTRIDGE OR SHELL CASE MAY BECOME “JAMMED” OR STUCK IN THE PISTOL. TO CLEAR THE JAM, (1) POINT THE MUZZLE IN A SAFE DIRECTION, (2) KEEP YOUR FINGER OFF THE TRIGGER AND ON THE MEMORY PAD, (3) REMOVE THE MAGAZINE, THEN (4) PULL BACK THE SLIDE AND LOCK IT TO THE REAR. THE JAMMED CARTRIDGE OR CASE CAN NOW BE REMOVED BY SHAKING OR PICKING IT OUT.



WARNING - FIRING

The slide opens and shuts quickly while firing. Keep face and hands away from rear of slide. Hot brass is ejected quickly and can burn you. Always wear shooting glasses, hat with brim, and hearing protection.



WARNING - ANY GUN MAY FIRE IF DROPPED

If dropped or struck, the pistol may fire.



WARNING

If dropped or struck the firearm should be inspected by a trained armorer/gunsmith for a complete function check. After the firearm was dropped or struck, mechanisms, including automatic safeties, may not function as intended resulting in accidental death or serious injury.

OPERATING INSTRUCTIONS



1. To remove the magazine, press the **magazine release button**, located near the **trigger guard**, with your thumb.

The Taurus TH Series pistols have an ambidextrous magazine release, it can be activated by left or right hand.



2. To load the magazine, hold the **magazine** with one of your hands and with the other one insert the cartridges one at a time, pressing them down and to the rear. Insert the **magazine** into the pistol until it is held by the **magazine catch**. If the **magazine** is not correctly inserted into the pistol, it can drop when you intend to shoot.



3. Hold the pistol with one hand keeping your finger away from the trigger and on the **memory pad**. With the other hand pull the **slide** backwards to its limit and release it. The **slide** will go forward under **recoil spring** pressure and will insert one cartridge in the **chamber**.



4. The pistol is now cocked and ready to fire by pulling the **trigger**. After firing, the **slide** will recoil from gas pressure, eject the empty cartridge case and feed another cartridge into the **chamber** from the **magazine**. The pistol will be ready to fire again. After the last round, the **slide** will remain in the open position held by the **slide catch**. In order to make it return to its rest position, press down on the **slide catch** just above the **left grip** or pull **slide** to the rear.



5. If you want to stop shooting before firing the last cartridge of a magazine, decock the firearm immediately by moving the **safety** downward (a) and then push the **safety lever** to the up (on) position.



6. Clear the firearm. Remove the magazine from your pistol. Open the action completely, and verify that the firearm is completely unloaded and contains no cartridges or cartridge case.

WARNING

Taurus TH Series pistols do not have a magazine disconnecter “safety”. They are capable of firing with the magazine removed.

WARNING

The manual safety lever must be in fully engaged for the manual Safety to work.

 **CAUTION**

Failure to make sure the manual safety lever is all the way in the "off" position will result in damage to the pistol.

 **WARNING - FIRING**

The slide opens and shuts quickly while firing. Keep face and hands away from rear of slide. Hot brass is ejected quickly and can burn you. Always wear shooting glasses, hat with brim, and hearing protection.

 **WARNING - ANY GUN MAY FIRE IF DROPPED**

If dropped or struck, the pistol may fire.

Intentionally left blank

DISASSEMBLY

WARNING

Always wear eye protection that is specified for use with firearms (ANSI Z87.1+) every time you handle your firearm for cleaning and maintenance.



1. Before disassembly always (1) Keep your finger off or the **trigger** and on the **memory pad**, (2) point the **muzzle** in a safe direction (3) remove the **magazine** by pressing the **magazine release button** (4) pulling the **slide** to the rear and locking back and (5) looking and feeling the **magazine well** and **chamber** to confirm the pistol is empty. An empty firearm cannot fire.



WARNING

After removing the magazine, always check the chamber and make sure it is empty.

2. Hold the pistol in the right or left hand in such a way that four fingers rest over the **slide** and thumb rests on the rear of the **grip**. Using the fingers draw back the slide about 1/8". With the other hand pull **disassembly latch** down. Release **slide**. Release **disassembly latch**.



3. Pull and release **trigger**. Then remove the **slide** from the **grip**.



4. Release **recoil spring assembly** from its position on the bottom of the **barrel**.

WARNING

Please take care to prevent the forcible ejection of the slide spring assembly plate and compressed slide spring assembly.



5. Remove the **barrel** from the **slide** by pulling it to the front and up.

MAGAZINE DISASSEMBLY

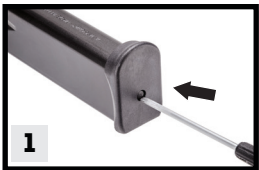

A) Use a **punch** to press in on **magazine spring seat/clip**.

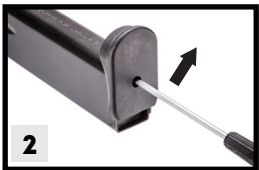

B) Slide the **magazine floor plate** toward the front of the **magazine** according Position 1 and 2.



C) Withdraw **magazine spring plate** and **magazine spring** from **magazine body**. Turn **magazine** upside down and remove magazine follower.



D) Assemble in reverse order.

WARNING

Please take care to prevent the forcible ejection of the magazine spring plate and compressed magazine spring.

WARNING

Always wear eye protection that is specified for use with firearms (ANSI Z87.1+) every time you handle your firearm for cleaning and maintenance.

WARNING

No further disassembly is recommended unless done by a skilled gunsmith.

BACKSTRAP DISASSEMBLY

WARNING

Make sure the magazine is removed and pistol is clear prior to backstrap removal.



The main function of the backstrap is to assure the users comfortability to reach the trigger in the proper position for a correct trigger press. There are three backstrap sizes available, with easy replacement, according to the instructions below:

A) REMOVAL: using an appropriate diameter punch, move the **backstrap pin** away from the **grip**. After that, remove the backstrap, pulling it towards the bottom.

B) REPLACEMENT: to assemble the **backstrap**, adjust it to the **grip** and insert the **pin**. A tool can be used to make the assembling process easier.

MAGAZINE IS REMOVED AND THE PISTOL IS CLEAR.

WARNING

No further disassembly is recommended unless done by a skilled gunsmith.

ASSEMBLY

In order to reassemble the pistol, proceed by reversing the disassembly procedure:

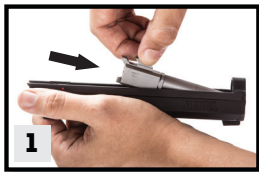

1. Replace the **barrel** in the **slide** pushing it to the rearward position.



2. Insert the **recoil spring** assembly into the **slide** over the **barrel**, compressing the **spring** slightly to get it into position.



3. The **slide** should be mounted on the **frame** and pulled fully to the rear and the **slide catch** must be moved upward to hold the **slide** to the rear.



4. You should cycle the **slide** several times, with no **magazine** inserted and an empty **chamber**, to insure that the **barrel / slide / frame** relationship is correct.

CARE AND MAINTENANCE

The firearm may be cleaned and lubricated under normal conditions with the disassembly steps described in pages 26-27.

In order to keep a firearm safe to use, it must be kept clean and covered with a light film of good quality oil to prevent corrosion. The barrel bore should be cleaned and left free of debris.

For normal cleaning, rub the pistol with a lightly oiled cloth. In the same way, proceed with the bore of the barrel. Excess oil should be removed. Dust should be removed from all crevices with a small clean brush.

Please note that a firearm with laser should not be cleaned in a well or supersonic machine that submerges the firearm as this can damage the laser system.

WARNING

Before cleaning, (1) point the muzzle in a safe direction, (2) keep your finger off the trigger and on the memory pad, (3) remove the magazine, then (4) pull back the slide and lock it to the rear, (5) look and feel the magazine well and chamber to confirm the pistol is empty. Never attempt to clean a loaded firearm.

EXPLODED VIEW

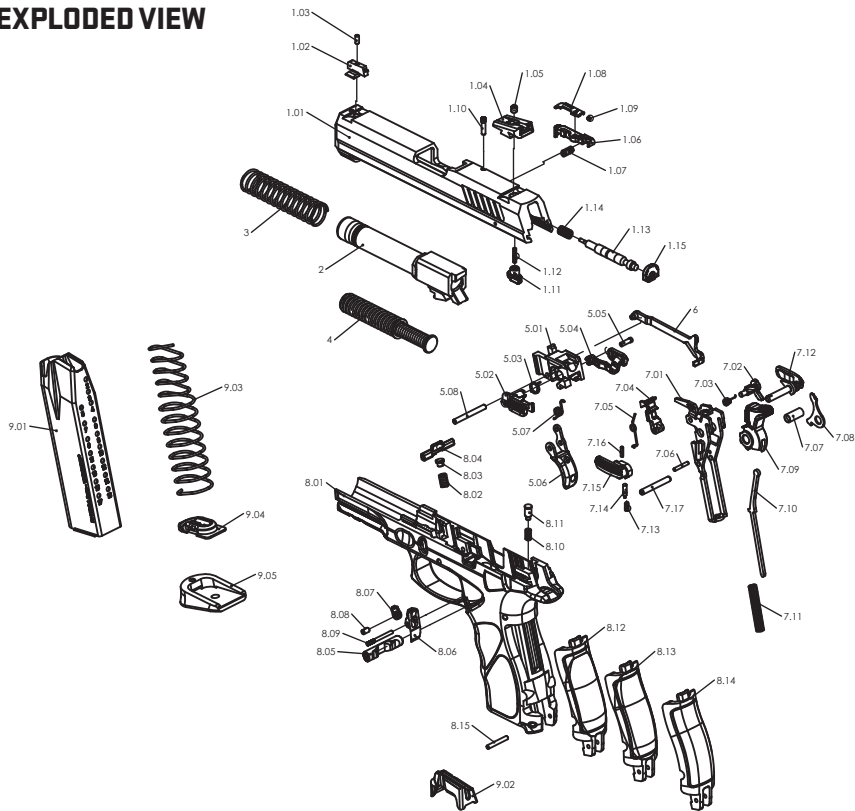

PART LIST

| | | | |
|------|---|------|------------------------------|
| 1 | SLIDE ASSEMBLY | 7.06 | SEAR PIN |
| 1.01 | SLIDE | 7.07 | HAMMER BUSHING |
| 1.02 | FRONT SIGHT | 7.08 | FIRING PIN BLOCK LEVER |
| 1.03 | FRONT SIGHT SCREW | 7.09 | HAMMER |
| 1.04 | REAR SIGHT | 7.10 | HAMMER SPRING GUIDE |
| 1.05 | REAR SIGHT SCREW | 7.11 | HAMMER SPRING |
| 1.06 | EXTRACTOR | 7.12 | MANUAL SAFETY RIGHT SIDE |
| 1.07 | EXTRACTOR SPRING | 7.13 | MANUAL SAFETY PLUNGER SPRING |
| 1.08 | LOADED CHAMBER INDICATOR | 7.14 | MANUAL SAFETY PLUNGER |
| 1.09 | LOADED CHAMBER INDICATOR SPRING | 7.15 | MANUAL SAFETY LEFT SIDE |
| 1.10 | EXTRACTOR PIN | 7.16 | MANUAL SAFETY PIN |
| 1.11 | FIRING PIN BLOCK | 7.17 | HAMMER SUPPORT PIN |
| 1.12 | FIRING PIN BLOCK SPRING | 8 | GRIP ASSEMBLY |
| 1.13 | FIRING PIN | 8.01 | GRIP |
| 1.14 | FIRING PIN SPRING | 8.02 | DISASSEMBLY LATCH SPRING |
| 1.15 | SLIDE CAP | 8.03 | DISASSEMBLY LATCH SPRING PIN |
| 2 | BARREL | 8.04 | DISASSEMBLY LATCH |
| 3 | BARREL RECOIL SPRING (ONLY T380 VERSION) | 8.05 | MAGAZINE RELEASE BUTTON |
| 4 | RECOIL SPRING ASSEMBLY | 8.06 | MAGAZINE RELEASE |
| 5 | CENTRAL SUPPORT ASSEMBLY | 8.07 | MAGAZINE RELEASE SPRING |
| 5.01 | CENTRAL SUPPORT | 8.08 | MAGAZINE RELEASE BUSHING |
| 5.02 | SLIDE CATCH LEFT SIDE | 8.09 | MAGAZINE RELEASE PIN |
| 5.03 | SLIDE CATCH SPRING | 8.10 | TRIGGER BAR PLUNGER SPRING |
| 5.04 | SLIDE CATCH RIGHT SIDE (ONLY STD VERSION) | 8.11 | TRIGGER BAR PLUNGER |
| 5.05 | SLIDE CATCH SCREW (ONLY STD VERSION) | 8.12 | BACKSTRAP - SMALL |
| 5.06 | TRIGGER | 8.13 | BACKSTRAP - MEDIUM |
| 5.07 | TRIGGER SPRING | 8.14 | BACKSTRAP - LARGE |
| 5.08 | CENTRAL SUPPORT FASTENING PIN | 8.15 | BACKSTRAP FASTENING PIN |
| 6 | TRIGGER BAR | 9 | MAGAZINE ASSEMBLY |
| 7 | HAMMER SUPPORT ASSEMBLY | 9.01 | MAGAZINE BODY |
| 7.01 | HAMMER SUPPORT | 9.02 | FOLLOWER |
| 7.02 | HAMMER CATCH | 9.03 | MAGAZINE SPRING |
| 7.03 | HAMMER CATCH SPRING | 9.04 | MAGAZINE SPRING PLATE |
| 7.04 | SEAR | 9.05 | MAGAZINE BOTTOM PLATE |
| 7.05 | SEAR SPRING | | |

TAURUS SERVICE

Should your firearm require adjustment or repair contact our Customer Care department at 800-327-3776.

Please follow these suggestions to expedite service in the United States to return any firearm to us for adjustment or repair.

1. Federal law permits you to return your firearm to the manufacturer for service via common carriers. However, state and local firearms laws vary greatly; you should consult your local prosecuting attorney regarding any restrictive laws in your jurisdiction regarding your shipment or receipt of firearms. With the above in mind, it is strongly recommended that any firearm sent to us for repair be sent through a federally licensed dealer.

2. All firearms must be shipped to us prepaid. **WE WILL NOT ACCEPT COLLECT SHIPMENTS.**

3. **Warranty Service:** If your product is covered under the Taurus® Limited Lifetime Warranty (<https://warranty.taurususa.com>) or was manufactured prior to January 1, 2017, you must contact Taurus to receive warranty service. You may contact Taurus by calling 800-327-3776, logging onto <https://taurususa.com>, or in writing: Taurus, Attn: Warranty Service, 100 Taurus Way, Bainbridge, GA 39817. Please include a description of the claimed defect, along with your name, address, telephone number, model and serial number of your firearm, proof of purchase, and date of purchase.

4. **FIREARMS MUST BE SHIPPED UNLOADED.** Double check the chambers of your firearm before shipping. If firearms are sent to Taurus in a loaded condition, we are required by law to notify the Federal authorities.

5. **DO NOT** include telescopic sights, custom grips, holsters, or other accessories with any firearm shipped to us.

PARTS

Firearms require periodic maintenance, inspection, adjustment and repair. If your pistol has a malfunction, be safe. Stop firing, “clear” and unload the pistol and take it to a qualified gunsmith. Before shooting it again, contact our Customer Care department if you have any questions.

If water, sand, or other foreign matter gets in your pistol, field strip it (see pages 26-30) and thoroughly clean it. Failure to keep your firearm clean and in proper working order can be dangerous.

Our Customer Care department maintains a full stock of replacement parts for current Taurus firearms. Even though most gunsmiths have the knowledge, training and ability to make the necessary repairs to your firearm, the skill and workmanship of any particular gunsmith is totally beyond our control. Should your firearm require service, return it to our Customer Care department.

Remember, unauthorized adjustments or parts replacement can void your warranty. If you choose to have someone else do the required work, the purchaser and/or installer of parts must accept full responsibility for the correct adjustment and function of the firearm.



TAURUS® LIMITED LIFETIME WARRANTY

Taurus® hereby provides the following **LIMITED LIFETIME WARRANTY**, to the original purchaser of the enclosed Taurus firearm subject to the terms and conditions set forth below. **THIS IS THE ONLY WARRANTY EXTENDED BY TAURUS COVERING THIS FIREARM.**

What does the warranty cover and what is its duration?

Taurus warrants to the original purchaser that the enclosed firearm was made free of defects in material, function, and workmanship. Taurus promises to remedy any defect in material, function or workmanship for the entire time that the original purchaser owns the firearm. This warranty covers the firearm's finish, grips, magazines, sights or accessories for the first year. Any claims of defect related to lasers must be directed to the manufacturer of the laser. This warranty terminates automatically upon the transfer of this firearm to any individual or entity other than the original purchaser.

Disclaimer and Limitation of Remedy.

ANY IMPLIED WARRANTIES OF MERCHANTABILITY IMPARTED BY STATE LAW WILL BE LIMITED TO ONE (1) YEAR.

Some States do not allow limitations on how long an implied warranty lasts, so the above-limitation may not apply to you.

ANY AND ALL INCIDENTAL AND CONSEQUENTIAL DAMAGES ARE EXPRESSLY DISCLAIMED UNDER ALL CIRCUMSTANCES.

Some States do not allow the exclusion or limitation of incidental or consequential damages, so the above limitation or exclusion may not apply to you. This **LIMITED LIFETIME WARRANTY** gives you specific legal rights, and you may also have other rights which vary from State to State.

Taurus will not be responsible for:

1. Defects or malfunctions resulting from careless handling, unauthorized adjustments or modifications.
2. Use of defective or improper ammunition, reloaded ammunition, corrosion, neglect, abuse, ordinary wear and tear or unreasonable use.
3. Criminal misuse, negligence or use under the influence of drugs or alcohol.

How do you obtain warranty service?

The warranty becomes effective only if activated by the original purchaser within thirty (30) days of the purchase date by registering online at: <https://warranty.taurususa.com> or by calling Taurus at 800-327-3776.

You must contact Taurus to receive warranty service. You may contact Taurus by calling 800-327-3776, logging onto <https://taurususa.com>, or in writing: Taurus, Attn: Warranty Service, 100 Taurus Way, Bainbridge, GA 39817. Please include a description of the claimed defect, along with your name, address, telephone number, model and serial number of your firearm, proof of purchase, and date of purchase.

NOTES

IMPORTANT DO NOT DISCARD

KEEP THIS MANUAL WITH THE FIREARM
UPON CHANGE OF OWNERSHIP.

TAURUS ARMAS, S.A.

Av. São Borja, 2181 – Prédio A
São Leopoldo/Fazenda São Borja
Rio Grande do Sul
93.035-411
Brasil

TAURUS INTERNATIONAL MANUFACTURING, INC.

100 Taurus Way
Bainbridge, GA 39817
Telephone: 1-800-327-3776

TAURUSUSA.COM

045-0005-00 Rev. 7

